

END FITTINGS

Anchors and brackets

AS1. Anchor

Steel
Galvanised
Locking clip included

Cat.no: 6412

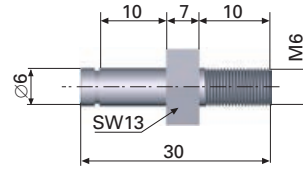

AS2. Anchor

Steel
Galvanised
Locking clip included

Cat.no: 6411

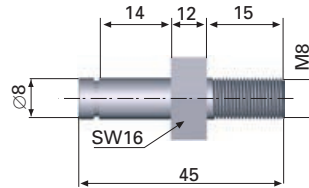
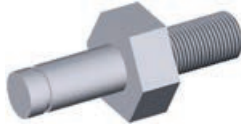

BK3. Bracket

For light applications
Steel
Galvanised
Bolt and locking clip included

Cat.no: 6410

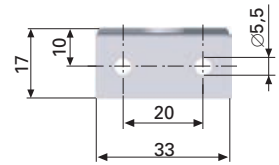
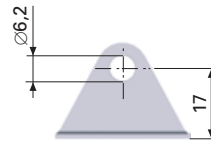

BK4. Bracket

For light applications
Steel
Galvanised

Cat.no: 6409

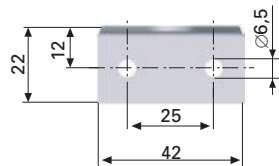
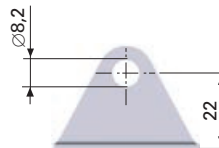

BK1. Bracket

For light applications
Steel
Galvanised
Bolt and locking clip included

Cat.no: 6408

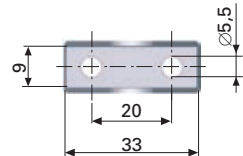
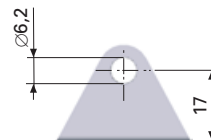

BK2. Bracket

For light applications
Steel
Galvanised
Bolt and locking clip included

Cat.no: 6407

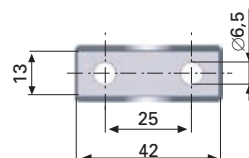
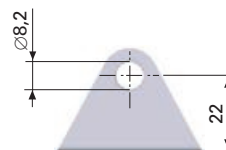

END FITTINGS

Brackets, extensions, clevises and locking clips



BK5. Bracket

Steel
Galvanised
Locking clip included

Cat.no: 4623

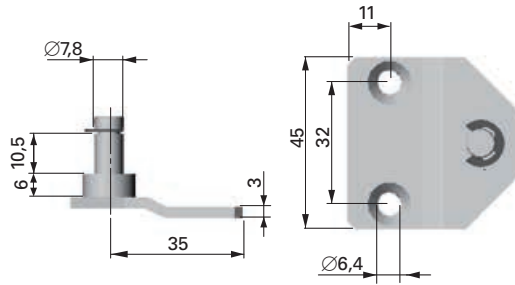

BK6. Bracket

Steel
Galvanised
Locking clip included

Cat.no: 4624

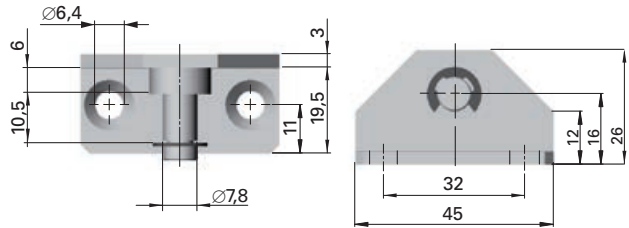

BK7. Bracket

Steel
Galvanised
Bolt and nut included

Cat.no: 4628

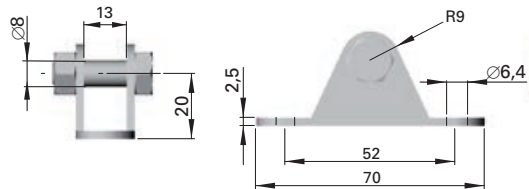

EX1. Extension

Steel 11SMnPb30+C
Electroplated ZnNi,
black

Cat.no: 5660

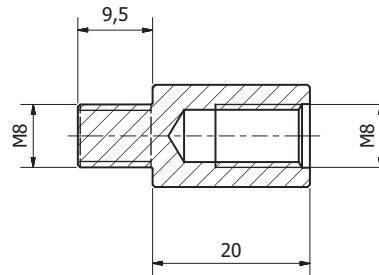

G1. Clevis M4

Steel
Galvanized

Cat.no: 601

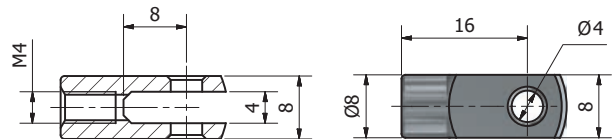
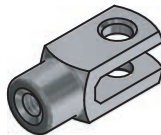

G2. Locking clip

Steel
Galvanized

Cat.no: 602

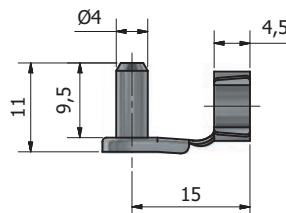

END FITTINGS

Brackets and fittings



FB1. Bracket
Plastic, black
Cat.no: 8962

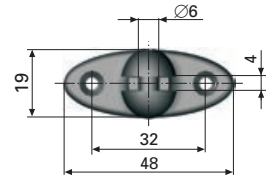
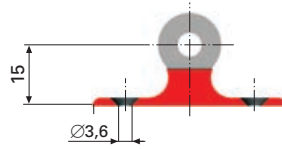

FB2. Bracket
Plastic, grey
Cat.no: 1115

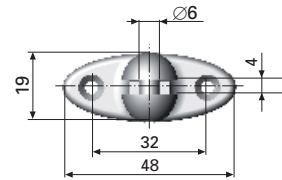
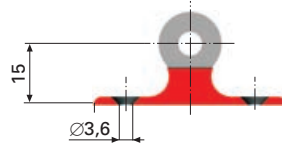

FB3. End fitting
Plastic, black
Cat.no: 8963

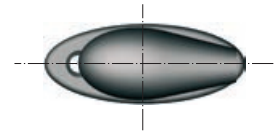
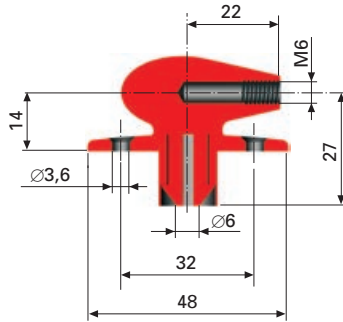

FB4. End fitting
Plastic, grey
Cat.no: 1116

