

CONSTANT FORCE SPRINGS

KKF

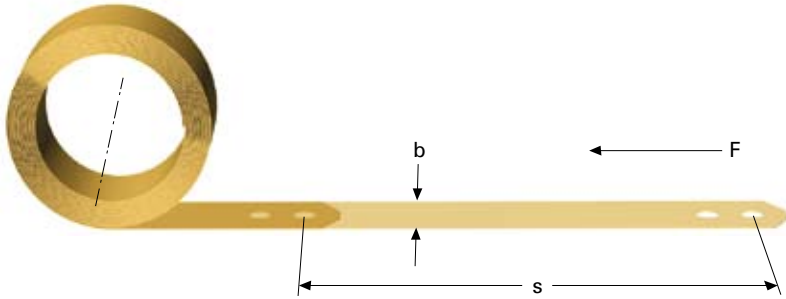

The constant force spring consists of strip material, which has been shaped and pre-tensioned into a tightly wound roll. The spring is used in a linear movement and produces almost constant force throughout its deflection. Constant force springs can be fitted in a number of ways and extended partly or completely. There is practically no limit on extension speed and acceleration.

Spring life

The life of the spring is determined by the relation between the diameter of the spring and the thickness of the material. See information for the relevant item. For applications demanding a higher number of oscillations, the spring must be changed once the recommended number of oscillations has been reached. Spring life is not time-dependent, it is only determined by the number of oscillations made.

Fitting

Fitting can be done in a number of ways. During long extensions, the spring must be laterally guided to prevent movement in a sideways direction. Suitable play on each side is 0.5–1.5 mm.

When fitting on a bearing or conduit, the spring can be located using its own force providing that sufficient strip length remains on the bearing. If there is no operating extension limit in the application, we recommend that a screw or rivet is used to secure the inner end of the spring.

Fitting example



A. Shaft fitting



B. Bearing or conduit



C. Bearing or conduit with inner fixing



D. Fitting in a location pocket



E. Fitting to a movable device

If the spring is fitted as shown in figures D or E, a low friction material must be used.

Fitting on a bearing and conduit

Our standard springs and slide bearings are normally supplied separately. Fitting is done by loosening the outer end of the spring and winding it onto the bearing (securing it if necessary), after which the complete spring is wound onto the bearing.



CONSTANT FORCE SPRINGS

KKF



Hole types

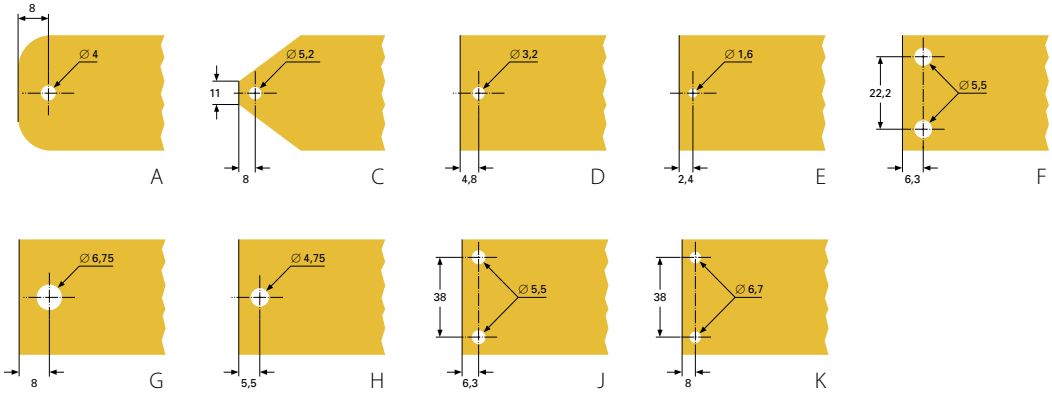

Application methods

Please note the maximum extended length decreases when two springs are installed as per figures 2, 3 and 5.



1. Single assembly



2. Dual assembly



3. Dual front to front



4. Dual back to back



5. Dual dual back to back

CONSTANT FORCE SPRINGS

KKF Series B

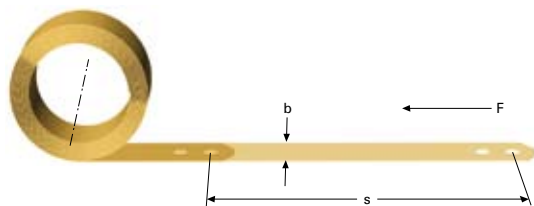
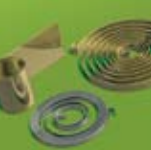

All dimensions are in mm

t = Strip thickness

b = Strip width

s = Travel

D_y = Outer diameter without bearing*

D_i = Inner diameter without bearing*

D_1 = Outer diameter fitted on slide bearing

D_2 = Inner diameter fitted on slide bearing (recommended approx. outer dimension of bearing)

F = Spring force in Newtons

A = Material length

* May vary in order to comply with the force specification.

Material: Stainless steel EN 10270-3-1.4310

Approximate life: 15 000 oscillations

1 kp = 9.80665 Newtons, 1 Newton = 0.10197 kp

Constant force springs for general use based on imperial dimensions. These springs are normally fitted on bearings. If the spring is to be placed directly onto a shaft, the chosen shaft diameter must afford sufficient play on the inner diameter to prevent the spring from locking onto the shaft.

t	b	s	D_i	D_y	D_1	D_2	F	A	Bore type	Cat.no
0,051	3,175	167	4,83	6,18	6,91	5,79	0,46	203	E	8036
0,076	3,175	252	7,24	9,25	10,3	8,69	0,7	305	E	8037
0,051	6,35	167	4,83	6,18	6,91	5,79	0,93	203	E	8038
0,102	4,76	338	9,67	12,36	13,8	11,6	1,4	406	E	8039
0,076	7,94	252	7,24	9,25	10,3	8,69	1,7	305	E	8040
0,102	9,52	338	9,67	12,36	13,8	11,6	2,8	406	D	8041
0,127	9,52	422	12,06	15,42	17,3	14,5	3,5	508	D	8042
0,127	12,7	422	12,06	15,42	17,3	14,5	4,7	508	D	8043
0,152	12,7	505	14,53	18,54	20,7	17,4	5,6	610	A	8044
0,152	15,88	505	14,53	18,54	20,7	17,4	7	610	A	8045
0,203	14,29	673	19,38	24,73	27,7	23,2	8,4	813	A	8046
0,254	15,88	844	24,23	30,92	34,5	29	11,7	1016	A	8047
0,254	19,05	844	24,23	30,92	34,5	29	14	1016	A	8048
0,305	19,05	1011	28,96	37,02	41,4	34,8	16,9	1219	A	8049
0,356	19,05	1179	33,78	43,18	48,3	40,6	19,6	1422	A	8070
0,305	25,4	1011	28,96	37,02	41,4	34,8	22,5	1219	C	8071
0,356	25,4	1179	33,78	43,18	48,3	40,6	26,3	1422	C	8072
0,406	25,4	1340	38,86	49,54	55,4	46,5	30	1626	C	8073
0,456	25,4	1515	43,43	55,48	62	52	34	1829	C	8074
0,356	38,1	1179	33,78	43,18	48,3	40,6	40	1422	F	8075
0,305	50,8	1011	28,96	37,02	41,4	34,8	45	1219	F	8076
0,457	38,1	1516	43,43	55,51	62	52	50	1829	F	8077
0,406	50,8	1340	38,86	49,54	55,4	46,5	60	1626	F	8078
0,635	38,1	2103	60,45	77,21	86,4	72,7	71	2540	G	8079
0,559	50,8	1852	53,09	67,86	76	63,7	83	2235	K	8080
0,635	50,8	2100	60,45	77,21	86,4	72,7	94	2540	K	8081

CONSTANT FORCE SPRINGS

KKF Series C



Series C is a programme based on the metric standard adapted for standard slide bearings. Springs can be supplied with or without the bearing and with assemblies for saddle or sideways fitting. See the following pages. Please note, the bearing is supplied unassembled.

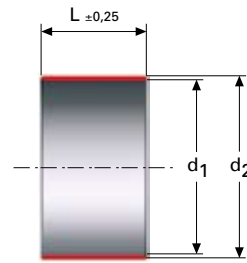
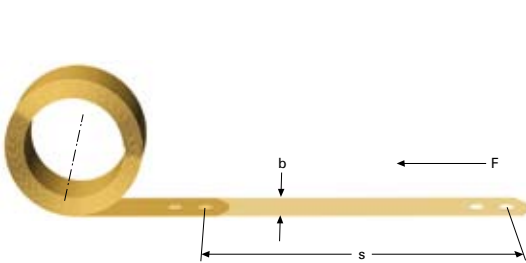

Spring

All dimensions are in mm

t = Strip thickness

b = Strip width

s = Travel

D_y = Outer diameter without bearing*

D_i = Inner diameter without bearing*

D_1 = Outer diameter fitted on slide bearing

D_2 = Inner diameter fitted on slide bearing

F = Spring force in Newtons $\pm 10\%$

A = Material length

* May vary in order to comply with the force specification.

Material: EN10270-3-1.4310

Slide bearing

All dimensions are in mm

d_1 = Internal diameter

d_2 = External diameter

L = Length

N_c = Life in approximate number of load cycles

Recommended shaft dimension: d_1

Material: SBT, lubrication free three-layer bearing comprising a steel case, a sintered middle layer of bronze and a sliding layer of PTFE.

1 kp = 9.80665 Newtons, 1 Newton = 0.10197 kp

t	b	s	D_y	D_i	D_1	D_2	F	A	Type of hole	d_1	d_2	L	N_c	Spring Bearing Cat. no. Cat.no.	
0,1	10	300	12,3	10	14	12	2,8	360	D	10	12	10	15000	1000	1042
0,1	10	300	15,9	14	17,7	16	1,6	400	D	12	16	10	40000	1001	1043
0,15	15	500	17,9	14	20,4	17	6,2	600	D	15	17	15	15000	1002	1044
0,15	15	500	22,3	19	25,8	23	4,4	640	D	20	23	15	40000	1003	1045
0,15	20	500	17,9	14	20,4	17	8,4	600	H	15	17	20	15000	1004	1046
0,15	20	500	22,3	19	25,8	23	5,5	640	H	20	23	20	40000	1005	1047
0,2	15	700	24,3	19	27,6	23	9,3	830	D	20	23	15	15000	1006	1048
0,2	15	700	33,1	29	37,6	34	4,3	900	D	30	34	15	40000	1007	1049
0,2	20	700	24,3	19	27,6	23	12,3	830	H	20	23	20	15000	1008	1047
0,2	20	700	33,1	29	37,6	34	5,7	900	H	30	34	20	40000	1009	1050
0,2	25	700	24,3	19	27,6	23	15,4	830	H	20	23	25	15000	1010	1051
0,2	25	700	33,1	29	37,6	34	7,1	900	H	30	34	25	40000	1011	1052



CONSTANT FORCE SPRINGS

KKF Series C

t	b	s	D _y	D _i	D ₁	D ₂	F	A	Type of hole	d ₁	d ₂	L	N _c	Spring Cat. no.	Bearing Cat. no.
0,25	15	1000	31,2	24	34,5	28	11,5	1170	D	25	28	15	15000	1012	1053
0,25	15	1000	39	33	44,3	39	6,1	1250	D	35	39	15	40000	1013	1054
0,25	20	1000	31,2	24	34,5	28	15,4	1170	H	25	28	20	15000	1014	1055
0,25	20	1000	39	33	44,3	39	8,1	1250	H	35	39	20	40000	1015	1056
0,25	25	1000	31,2	24	34,5	28	19,2	1170	H	25	28	25	15000	1016	1057
0,25	25	1000	39	33	44,3	39	10,1	1250	H	35	39	25	40000	1017	1058
0,3	20	1000	37,4	30	42,4	36	17	1200	H	32	36	20	15000	1018	1059
0,3	20	1000	48	42	55,2	50	9,8	1270	H	45	50	20	40000	1019	1060
0,3	25	1000	35,8	28	40,7	34	21,3	1200	H	30	34	25	15000	1020	1052
0,3	25	1000	48	42	55,2	50	12,3	1270	H	45	50	25	40000	1021	1061
0,3	30	1000	37,4	30	42,4	36	25,5	1200	G	32	36	30	15000	1022	1062
0,3	30	1000	48	42	55,2	50	14,7	1270	G	45	50	30	40000	1023	1063
0,4	25	1500	48,8	37	54,4	44	33,7	1850	G	40	44	25	15000	1024	1064
0,4	25	1500	64,8	56	72,8	65	16,3	1900	G	60	65	30	40000	1025	1065
0,4	30	1500	48,8	37	54,4	44	40,4	1850	G	40	44	30	15000	1026	1066
0,4	30	1500	64,8	56	72,8	65	19,5	1900	G	60	65	30	40000	1027	1065
0,4	40	1500	48,8	37	54,4	44	54	1850	F	40	44	40	15000	1028	1067
0,4	40	1500	65	56	73	65	26	1950	F	60	65	40	40000	1029	1068
0,5	30	1500	58,6	46	66	55	51,2	1900	G	50	55	30	15000	1030	1069
0,5	30	1500	75,1	65	88,6	80	27,9	2000	G	75	80	30	40000	1031	1070
0,5	40	1500	58,6	46	66	55	68,3	1900	F	50	55	40	15000	1032	1071
0,5	40	1500	75,1	65	88,6	80	37,1	2000	F	75	80	40	40000	1033	1072
0,5	50	1500	58,6	46	66	55	85,3	1900	F	50	55	50	15000	1034	1073
0,5	50	1500	75,1	65	88,6	80	46,5	2000	F	75	80	50	40000	1035	1074
0,6	40	2000	69,2	53	78,9	65	100	2400	F	60	65	40	15000	1036	1068
0,6	40	2000	100,2	88	115,6	105	35,7	2700	F	100	105	40	40000	1037	1075
0,6	50	2000	69,2	53	78,9	65	125,2	2400	F	60	65	50	15000	1038	1076
0,6	50	2000	100,2	88	115,6	105	44,6	2700	F	100	105	50	40000	1039	1077
0,6	60	2000	69,2	53	78,9	65	150,2	2400	K	60	65	60	15000	1040	1078
0,6	60	2000	100,2	88	115,6	105	53,5	2700	K	100	105	60	40000	1041	1079

CONSTANT FORCE SPRINGS

Assembly for sideways mounting

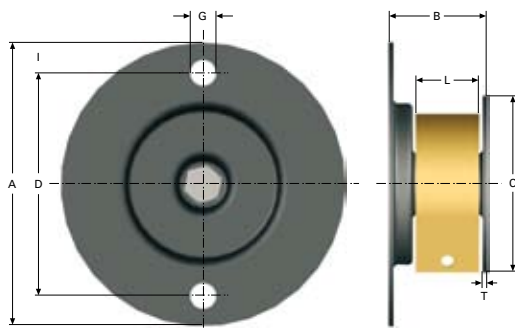

Fitting for sideways installation of series C constant force springs. Springs can be fitted for output either at the top or the bottom. The fitting is supplied unassembled. Springs and slide bearings must be ordered separately.

Material: SPD

Finish: FZB + chrome

A	B	C	D	G	L	T	Fits spring no.	Cat.no
46	16	28	38	4,4	10	0,75	1000	4713
46	16	28	38	4,4	10	0,75	1001	4714
46	21	28	38	4,4	15	0,75	1002	4715
46	26	28	38	4,4	20	0,75	1004	4716
66	22	42	55	4,4	15	0,75	1003, 1006	4717
66	27	42	55	4,4	20	0,75	1005, 1008	4718
66	32	42	55	4,4	25	0,75	1010	4719
66	22	42	55	4,4	15	0,75	1012	4720
66	27	42	55	4,4	20	0,75	1014	4721
66	32	42	55	4,4	25	0,75	1016	4722
78	23	52	68	5,5	15	1	1007	4723
78	28	52	68	5,5	20	1	1009	4724
78	33	52	68	5,5	25	1	1011, 1020	4725
78	28	52	68	5,5	20	1	1018	4726
78	38	52	68	5,5	30	1	1022	4727
78	23	52	68	5,5	15	1	1013	4728
78	28	52	68	5,5	20	1	1015	4729
78	33	52	68	5,5	25	1	1017	4730
90	34	65	80	5,5	25	1	1024	4731
90	39	65	80	5,5	30	1	1026	4732
90	49	65	80	5,5	40	1	1028	4733
90	29	65	80	5,5	20	1	1019	4734
90	34	65	80	5,5	25	1	1021	4735
90	39	65	80	5,5	30	1	1023	4736
125	41	100	115	6,5	30	1,25	1030	4737
125	51	100	115	6,5	40	1,25	1032	4738
125	61	100	115	6,5	50	1,25	1034	4739
125	41	100	115	6,5	30	1,25	1025, 1027	4740
125	51	100	115	6,5	40	1,25	1029, 1036	4741
125	61	100	115	6,5	50	1,25	1038	4742
125	71	100	115	6,5	60	1,25	1040	4743
125	41	100	115	6,5	30	1,25	1031	4744
125	51	100	115	6,5	40	1,25	1033	4745
125	61	100	115	6,5	50	1,25	1035	4746
156	52	130	145	4 x 6,5	40	1,25	1037	4747
156	62	130	145	4 x 6,5	50	1,25	1039	4748
156	72	130	145	4 x 6,5	60	1,25	1041	4749



CONSTANT FORCE SPRINGS

Assembly for saddle mounting

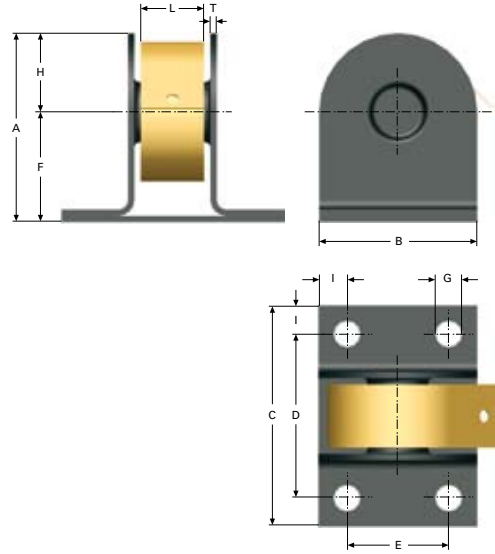

Fitting for saddle installation of series C constant force springs. Springs can be fitted for output either at the top or the bottom. The fitting is supplied unassembled. Springs and slide bearings must be ordered separately.

Material: SPD

Finish: FZB + chrome

A	B	C	D	E	F	G	H	I	L	T	Fits spring no.	Cat.no
29	25	35	26	16	16,5	4,2	12,5	4,5	10	1	1000	1080
29	25	35	26	16	16,5	4,2	12,5	4,5	10	1	1001	1081
29	25	40	31	16	16,5	4,2	12,5	4,5	15	1	1002	1082
29	25	45	36	16	16,5	4,2	12,5	4,5	20	1	1004	1083
47	40	50	38	28	27	5,2	20	6	15	1,25	1003, 1006	1084
47	40	55	43	28	27	5,2	20	6	20	1,25	1005, 1008	1085
47	40	60	48	28	27	5,2	20	6	25	1,25	1010	1086
47	40	50	38	28	27	5,2	20	6	15	1,25	1012	1087
47	40	55	43	28	27	5,2	20	6	20	1,25	1014	1088
47	40	60	48	28	27	5,2	20	6	25	1,25	1016	1089
61	50	50	38	38	36	5,2	25	6	15	1,5	1007	1090
61	50	55	43	38	36	5,2	25	6	20	1,5	1009	1091
61	50	60	48	38	36	5,2	25	6	25	1,5	1011, 1020	1092
61	50	55	43	38	36	5,2	25	6	20	1,5	1018	1093
61	50	65	53	38	36	5,2	25	6	30	1,5	1022	1094
61	50	50	38	38	36	5,2	25	6	15	1,5	1013	1095
61	50	55	43	38	36	5,2	25	6	20	1,5	1015	1096
61	50	60	48	38	36	5,2	25	6	25	1,5	1017	1097
76	60	70	54	44	46	6,2	30	8	25	2	1024	1098
76	60	75	59	44	46	6,2	30	8	30	2	1026	1099
76	60	85	69	44	46	6,2	30	8	40	2	1028	1100
76	60	65	49	44	46	6,2	30	8	20	2	1019	1101
76	60	70	54	44	46	6,2	30	8	25	2	1021	1102
76	60	75	59	44	46	6,2	30	8	30	2	1023	1103
121	90	85	65	70	76	8,3	45	10	30	2	1030	1104
121	90	95	75	70	76	8,3	45	10	40	2	1032	1105
121	90	105	85	70	76	8,3	45	10	50	2	1034	1106
121	90	85	65	70	76	8,3	45	10	30	2	1025, 1027	1107
121	90	95	75	70	76	8,3	45	10	40	2	1029, 1036	1108
121	90	105	85	70	76	8,3	45	10	50	2	1038	1109
121	90	115	95	70	76	8,3	45	10	60	2	1040	1110
121	90	85	65	70	76	8,3	45	10	30	2	1031	1111
121	90	95	75	70	76	8,3	45	10	40	2	1033	1112
121	90	105	85	70	76	8,3	45	10	50	2	1035	1113
160	130	110	85	105	95	8,3	65	12,5	40	2,5	1037	
160	130	120	95	105	95	8,3	65	12,5	50	2,5	1039	
160	130	130	105	105	95	8,3	65	12,5	60	2,5	1041	